

NAVSHIPS 93210

UNCLASSIFIED

TECHNICAL MANUAL

for

SINGLE SIDEBAND
CONVERTER
CV-591A/URR
MODEL MSR-4

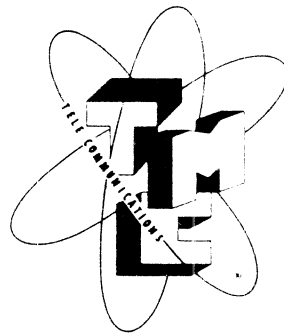

THE TECHNICAL MATERIEL CORPORATION
MAMARONECK, N. Y.

OTTAWA, ONTARIO

BUREAU OF SHIPS
DEPARTMENT OF THE NAVY

Issue Date: 30 October 1958

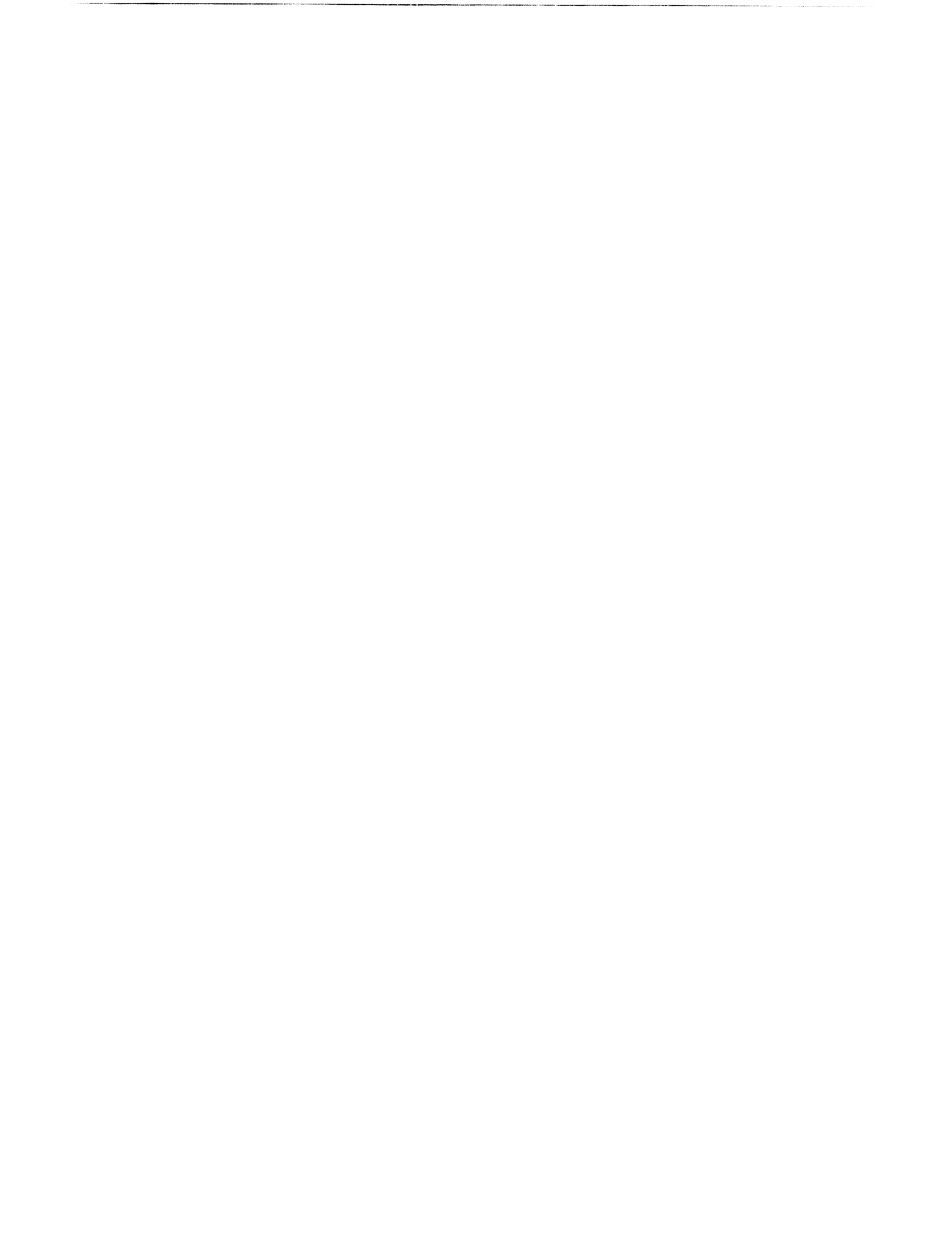

SECTION I

GENERAL DESCRIPTION

1. PURPOSE AND BASIC PRINCIPLES

The TMC Model MSR, Single Sideband Converter will, in a number of ways, improve operation of certain radio receivers for various modes of operation. The overall skirt selectivity of most receiving systems is greatly sharpened, rejecting unwanted adjacent signals or interference with no detrimental effect to the desired signal. The tuning of single sideband signals is greatly simplified since the final tuning is done at the MSR, not the receiver. A mechanical and electrical bandspread tunes over the I. F. bandpass. This effective vernier easily tunes SSB or exalted carrier AM signals within cycles of correct tone. Either sideband is selectable, either with the bandpass tuning feature or by inverting the osc.separation. CW, MCW and FS signals are easily tunable with the bandspread feature.

For extreme stability, the first oscillator is switched to crystal control for both upper and lower sideband positions.

The local or remote tuned VFO feature of the MSR permits operation with any receiver having an I. F. nominally centered at 455 kc. However, when the oscillator is switched to crystal control and the proper crystals inserted, most any receiver I. F. may be accommodated. The required I. F. connection between the receiver and MSR through a low loss coaxial cable is as follows:

AN/FRR-49(v) to MSR, BNC connector to BNC.

R-840/URR to MSR, Phono connector to BNC.

R-390/URR to MSR, BNC connector to BNC.

R-274B/URR to MSR, UHF connector to BNC.

The audio output is available in three levels:

1. 2 watts for 600 ohm line or 8 ohm loudspeaker.
2. 150 milliwatts for 600 ohm line or 8 ohm loudspeaker.
3. 0 dbm/1 milliwatt for 600 ohm telephone line.

Terminals at the rear panel provide the simple connections for remote control of the main features of the MSR without modifications or the use of additional lines or tones when used

in the TMC RCR system. By this means it is possible to remotely or locally tune the MSR across the receiver I. F. passband, select sidebands with a remote indication of which sideband is in use, and still retain all of the remote control features of the RCR system.

2. DESCRIPTION OF UNIT

The Model MSR is shown in Figure 1-1. The panel is 3/16 inch thick by 19 inches long by 5-1/4 inches high and finished in TMC grey enamel. The chassis extends 13-1/2 inches behind the panel and is self supporting.

All operational controls are located on the front panel. These controls are similar in function and effect to those found on any receiver. The BANDSPREAD control tunes the MSR over a limited frequency range. A MANUAL/XTAL switch sets the first oscillator to either variable or fixed crystal operation. The BFO, AVC and AUDIO GAIN controls perform similar functions as on a receiver.

Input and output connections are made on the rear apron.

3. TECHNICAL SPECIFICATIONS

Types of Reception:

- SSB-Selectable Sideband
- CW-MCW
- AM-Selectable Sideband
- Exalted Carrier AM
- Simultaneous AM-FS

Sideband Selection:

- Upper or Lower Sideband by means of Crystal or Calibrated Bandspread Oscillator.

Remote Control Features:

- Selection of Upper or Lower Sideband
- Selection of Mode of Operation
- AM-CW-MCW-SSB and Exalted Carrier
- +3 kc Bandspread Tuning
- AVC ON/OFF
- BFO ON/OFF

Remote Control Facilities:

- May be used with AN/FRA-19 (V) or AN/FRA-501-Remote Control Systems and AN/FRR-49(V) or AN/FRR-502-Receiving Systems without any system modification.

Input Frequency Range:

- (a) 452-458 Kc (when MSR oscillator is variable or normal crystal is used).
- (b) 225 kc to 1.5 mc when MSR oscillator is crystal controlled only.

Input Voltage Range:

0.1-10 Volts RMS.

Input Impedance:

240 K ohms

Filter Characteristics:

3.2 kc at 3 db Points
5.2 kc at 45 db Points

AVC Characteristics:

With 40 db change in input, output remains constant within 9 db.

AVC Speeds:

SLOW/FAST

Noise Limiter:

Balanced Type

Output:

High; 2 watts, 600 ohms, 8 ohms.
Low; 0 dbm, 600 ohms.
150 mw, 600 ohm, 8 ohm.

Output Impedances:

Loudspeaker 8 ohms
Line 600 ohms
Head Set-High or Low

Front Panel Control:

POWER/OFF
AUDIO GAIN Control
SIDEBAND UPPER/LOWER Switch
SIDEBAND Indicator Lighting
MANUAL/XTAL Switch
BANDSPREAD Control
AVC ON/OFF Switch

AVC FAST/SLOW Switch

BFO ON/OFF Switch

PHONES Jack

Power Indicator

Rear Panel Facilities:

IF Input Jack

Threshold Control

AC Power Input

Audio Output Terminal

Remote Control Terminal

High/Low Output Level Control

Input Power Requirements:

110/220 Volts 50/60
Cycles, 65 watts

Size:

5-1/4" high x 19" wide x 13-1/2" deep

Mounting:

Standard WE Rack

Weight:

24 lbs. net

Tube Complement:

12AU7 Relay Driver

12AU7 Amplifier and Rectifier

12AT7 17 kc Oscillator & Audio Amplifier

6J6 Reactance Tube

6AG5 1st Oscillator

6BA6 IF Amplifier

6BE6 1st Mixer

6BE6 2nd Mixer

6AL5 Noise Limiter

6AQ5 Audio Power Amplifier

5Y3 Power Rectifier

OA2 Voltage Regulator

Components and Construction:

Equipment manufactured in accordance with JAN/MIL Specifications wherever practicable.

SECTION II THEORY OF OPERATION

1. GENERAL DESCRIPTION OF CIRCUITS

The combination of a specially designed filter circuit and a frequency bandsread oscillator provides sharp discrimination between a desired signal and undesired adjacent interference. This is accomplished by easy tuning of the bandsread oscillator. The BANDSPREAD control tunes this oscillator over a restricted range of ± 3 kc from its center frequency. Remote tuning of this function is accomplished with a reactance circuit. The frequency of the 1st oscillator is centered on 472 kc for reception of the upper sideband and 438 kc for reception of the lower sideband. These frequencies can be made more stable by switching in crystals with the MANUAL/XTAL control.

The selection of upper or lower sideband is made through a relay. Operation is accomplished with a front panel push-button or through remote control of the relay driver stage. The indication of the sideband selected is shown by front panel lamps or remotely by tone pitch.

The carrier for SSB, exalted AM, or CW is reinserted at the second mixer by the BFO. This fixed oscillator is turned on or off by a relay which is operated either with the front panel BFO switch or a remotely controlled switch. A

low pass filter passes the desired products which are now at audio frequency. The audio amplifier stages provide a high level output, 2 watts for a 600 ohm line or 8 ohm loudspeaker; and 2 low level outputs, 0 dbm for telephone lines and 150 milliwatts for 600 ohm line or 8 ohm loudspeaker.

See Figure 2-1 for a simplified picture of how the MSR operates in combination with a double conversion receiver. Note that in the receiver conversion process, when the 1st oscillator is above the R. F. signal frequency, a reversal of sideband positioning occurs in the I. F., which places the lower sideband on the upper side of the carrier and the upper sideband on the lower side. In any subsequent conversion process a reversal again occurs if the oscillator is above the I. F., however, no reversal occurs if the oscillator is below the I. F. Since, with the normal single or double conversion receiver the sidebands are as shown in Figure 2-1, the MSR selects the proper sideband. But, where the sidebands are reversed it is necessary to remove and switch the front panel sideband indicators as explained in section III.

The receiver chosen is one in which the 1st I. F. is 3,955, however, other combinations are also useable. For example, had the receiver 1st

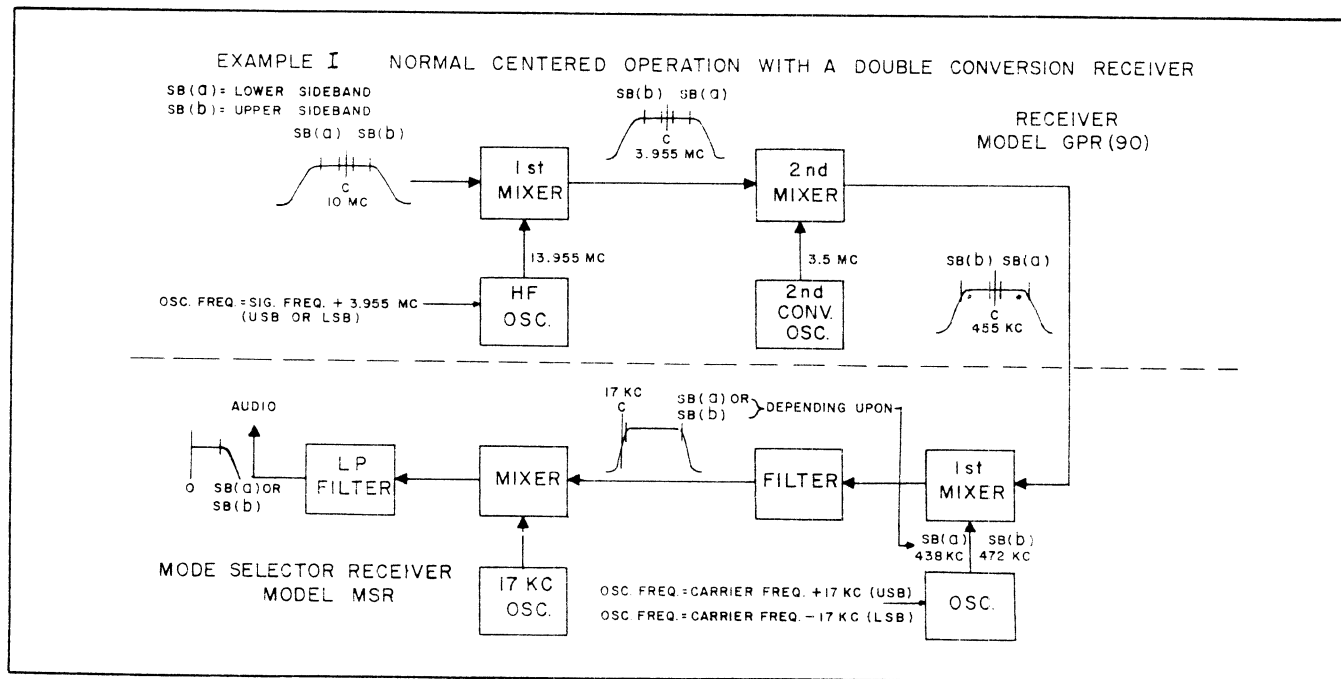

CK-347

Figure 2-1. Block Diagram (Example I) MSR/GPR-90

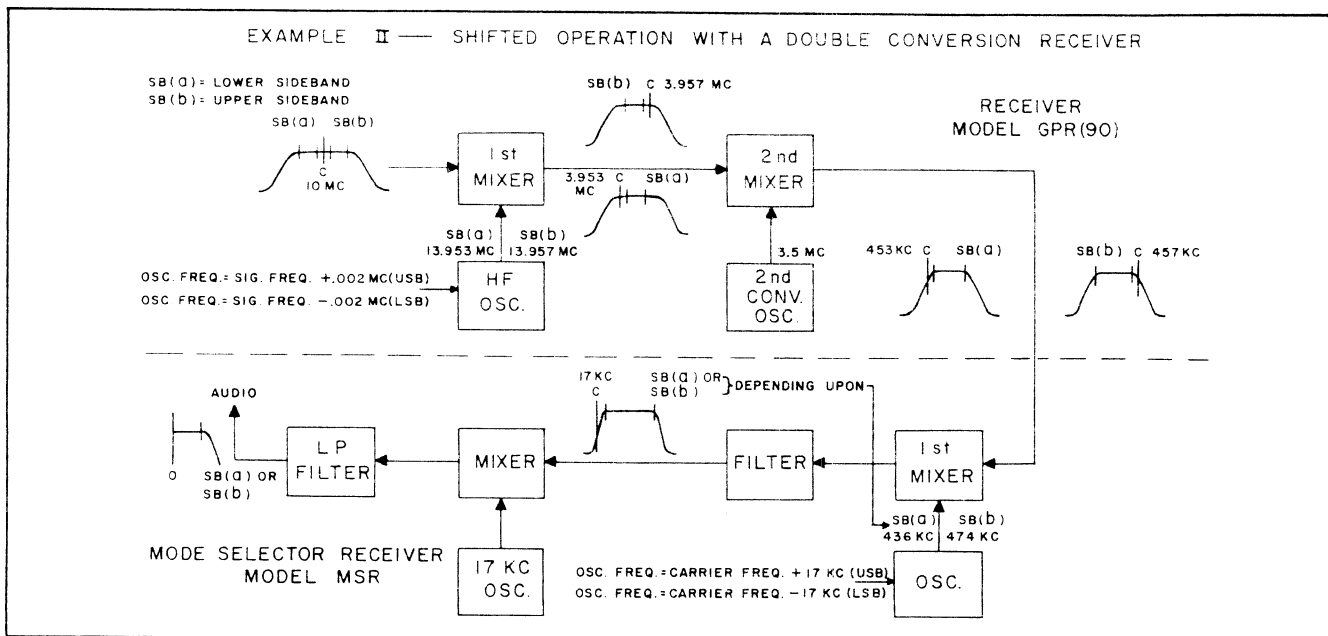

CK-346

Figure 2-2. Block Diagram (Example II) MSR/GPR-90

I. F. been 2.5 mcs and the incoming signal still centered at 10 mcs, the H. F. oscillator would have been at 12.5 mcs. Still further, had the receiver been of the single conversion type (such as the TMC Model FFR) then the H. F. oscillator would have been at $10 + .455$ or 10.455 mcs. In each case, the end result is the injection of a signal centered at 455 kc into the MSR. The MSR then beats its internal 1st oscillator with the input signal so that the imaginary or real carrier appears at 17 kc and one or the other sideband fits within the filter limits.

The same result can be obtained with the internal frequency except that now the MSR 1st oscillator has to be shifted to a new point which will still result in the real or imaginary carrier appearing at 17 kc. Since the MSR oscillator, in the VAR position, will produce products in the filter region only when the signal input is near 455 kc, it cannot be used with other I. F.'s. However, in crystal position, a crystal may be chosen which will permit operation with almost any I. F. (Using the equations of Figure 2-1 or 2-2).

Each mixer, in both the receiver or MSR, operates in such a way that a whole "slot" or band of frequencies representing the carrier and its sidebands is simply shifted so that they appear within the bandpass of the circuits which follow. If the receiver has a wide I. F. (perhaps ± 4 kc at the 3 db points) then the system bandpass will be that of the MSR filters (-3 db at 350 cps and 3.2 kc). If, on the other hand, the receiver is of the Navy I. F. type (perhaps ± 2.5 kc at the 6 db points) then the system bandpass be-

comes that of the receiver I. F. because it is the narrowest. The MSR filter accepts only one sideband at a time, therefore, the other sideband is simply occupying receiver I. F. space which is not being used. In the case of single sideband, this waste of receiver bandwidth is even more apparent because a segment of the receiver I. F. is completely unoccupied. If, on the other hand, the receiver is tuned so that the unused sideband slides off the edge of the bandpass curve and the desired sideband occupies the center of the bandpass, then the most efficient use is being made of the spectrum available. In this case, more information may be transmitted and received (for example, in the form of more F. S. channels) or improved audio quality will result. It has been determined that for a combination of the Model FFR or GPR-90 with the Model MSR, the optimum shift is 2 kc and an illustration of such a set-up is shown in Figure 2-2.

1. FOR UPPER SIDEBAND RECEPTION.
 - A. Receiver - choose the oscillator injection frequency (variable or crystal) to be 2 kc above the normal injection frequency.
 - B. MSR - use 474 kc crystal in socket Y2 or set BANDSPREAD tuning dial 2 kc above center.
2. FOR LOWER SIDEBAND RECEPTION.
 - A. Receiver - choose the oscillator injection frequency (variable or crystal)

to be 2 kc below the normal injection frequency.

- B. MSR - use 436 kc crystal or set BANDSPREAD tuning dial 2 kc below center.

For example, suppose normally centered operation (Figure 2-1) is desired with a double conversion receiver having a 1st I. F. of 3.5 mcs, a 2nd I. F. of 350 kc, and the received signal is centered at 10 mcs, the H. F. oscillator must then be at 10 + 3.5 or 13.5 mcs. The second oscillator must be at 3.15 mcs to produce the 350 kc 2nd I. F. Then, in order to bring the real or imaginary carrier to 17 kc, a 367 kc (350 + 17) or a 333 kc (350 - 17) crystal must be inserted in the MSR to produce the upper or lower sideband.

In all the preceding paragraphs, the assumption has been made that the real or imaginary carrier will appear at 17 kc within the MSR. This will be so in all cases of single sideband or exalted carrier operation. However, in normal AM, CW, or FS operation, the incoming signal must be shifted for several reasons:

1. In Normal AM Operation:

In this case, the 17 kc local oscillator within the MSR is turned off and the signal must supply its own carrier. If the carrier were brought in at 17 kc, it would be down on the slope of the filter and the proper sideband to carrier amplitude relationship would be disturbed. For this reason, the carrier must be off-set by about 400 cps (to 17.4 kc). This may be done by means of the variable 1st oscillator within the MSR or by shifting the receiver by the same amount if xtals are used in the MSR.

2. CW Operation:

If the signal were centered at 17 kc, a zero beat would result with the MSR 17 kc oscillator and nothing would be heard. For this reason, either the receiver oscillator or the MSR oscillator must be shifted by an amount equal to the beat note required (usually about 1 kc).

3. F. S. Operation:

As in CW operation (above), the receiver oscillator or MSR must be shifted but in this case, by an amount which will produce a space at 2125 cps and a mark at 2975. Then standard mark and space beat tones are used and the amount of oscillator shift will, of course, be determined by the tones required.

2. CIRCUIT ANALYSIS

The Block Diagram Figure 2-3 presents a simplified outline of the functions of the MSR and how they are accomplished.

THE AVC SYSTEM (V1A, B). - The AVC Amplifier and Rectifier provides two kinds of control on the first amplifier. A fast time constant is used to control signals which have an ever present component, i.e. AM, MCW, FS. A slow time constant will hold the amplifier gain steady for a longer period for SSB and CW signals. The gain of the amplifier is wide open when the AVC is OFF.

THE FIRST MIXER (V3). - The incoming signal is mixed with the First Oscillator to place it in proper position relative to the bandpass filter. Since the filter extends from 17.3 kc to 20.5 kc and the 17 kc BFO follows, the signal carrier position must be placed at 17 kc to produce the correct tone.

THE FIRST OSCILLATOR (V8). - Provides the tunable frequency source for correctly tuning the signal in the bandpass filter. It may be either variable or crystal controlled. When variable it is tuned with the front panel BANDSPREAD control or with the reactance control.

THE REACTANCE MODULATOR (V9). - The reactance placed across the first oscillator tuned circuit is varied to change frequency. A ± 4.5 VDC input to the reactance stage is sufficient to vary the oscillator ± 3 kc. The voltage is obtained from the BFO channel of the TMC Model RCR Remote Control Receiver System.

RELAY DRIVER (V10A). - As the R. F. gain control on the RCR system is turned to reduce the gain of the FFR receiver the required voltage out of the RSD performing this action reaches a certain level. When the level is such that the receiver is fully silent its negative level will be sufficient to cut off the relay driver (V10A) and deenergize K3. This action in turn trips the sideband two step relay K2.

SIDEBAND SELECTOR RELAY (K2). - Operation of the relay driver or the front panel push-button advances the sideband selector relay one position. This changes the first oscillator frequency from upper to lower sideband selecting frequency or vice versa.

BANDPASS FILTER (Z1). - After the First Mixer, the filter passes a band of frequencies between 17.3 kc and 20.5 kc. The skirts provide the sharpness required for attenuation of unde-

sirable adjacent signals. See Block Diagram Figure 2-3.

THE SECOND MIXER (V4). - The signal passed by the bandpass filter is demodulated in either of two ways. If a carrier is normally present and allowed to pass through the filter, such as AM, normal demodulation will take place. If no normal carrier is present, such as SSB, a carrier is reinserted.

THE BFO (V6A). - A stable 17 kc oscillator provides the reinserted carrier for SSB, exalted AM and produces the beat note for CW and FS signals.

THE BFO RELAY (K1). - The BFO is turned on or off by proper actuation of the relay. The front panel BFO switch or a remote paralleled switch actuates the relay.

SIDEBAND TONE GENERATOR (V9B). - By proper manipulation of the R. F. gain control of the RSC this circuit generates a tone, high or low, which will indicate to the remote operator which sideband (upper or lower) is in use. The tone be-

comes strong enough to be heard only after the R. F. gain has succeeded in fully silencing the normal receiver action.

LOW PASS FILTER (Z2). - Following the second mixer the low pass filter attenuates any products above 5 kc. The resultant is the desired audio.

AUDIO AMPLIFIERS (V5B, V6). Three levels of output are provided. The output level control in the HIGH position permits the full two watts of the amplifier to be available for the 600 ohm line or 8 ohm loudspeaker. In the LOW position, the gain of the amplifier is reduced so that 150 milliwatts is available for the 600 ohm line or 8 ohm loudspeaker, and 0 dbm or 1 milliwatt for 600 ohm telephone line. A phone jack on the front panel permits monitoring of the output without disabling.

POWER SUPPLY (V10). - The power supply is self contained and provides the necessary AC filament and DCB+ voltages. A regulated +150 V. stabilizes the First Oscillator and BFO.

LIST OF CROSS REFERENCES BETWEEN COMMERCIAL DESIGNATIONS AND GOVERNMENT NOMENCLATURE

DESIGNATION	NOMENCLATURE
FFR	AN/FRR-49 (V)
RCR	AN/FRA-501
RSC	C-5027 thru C-5031/FRA-501
GPR-90	R-840/URR
RSD	CV-5013 thru CV-5017/FRA-501
MSR-4	CV-591A/URR

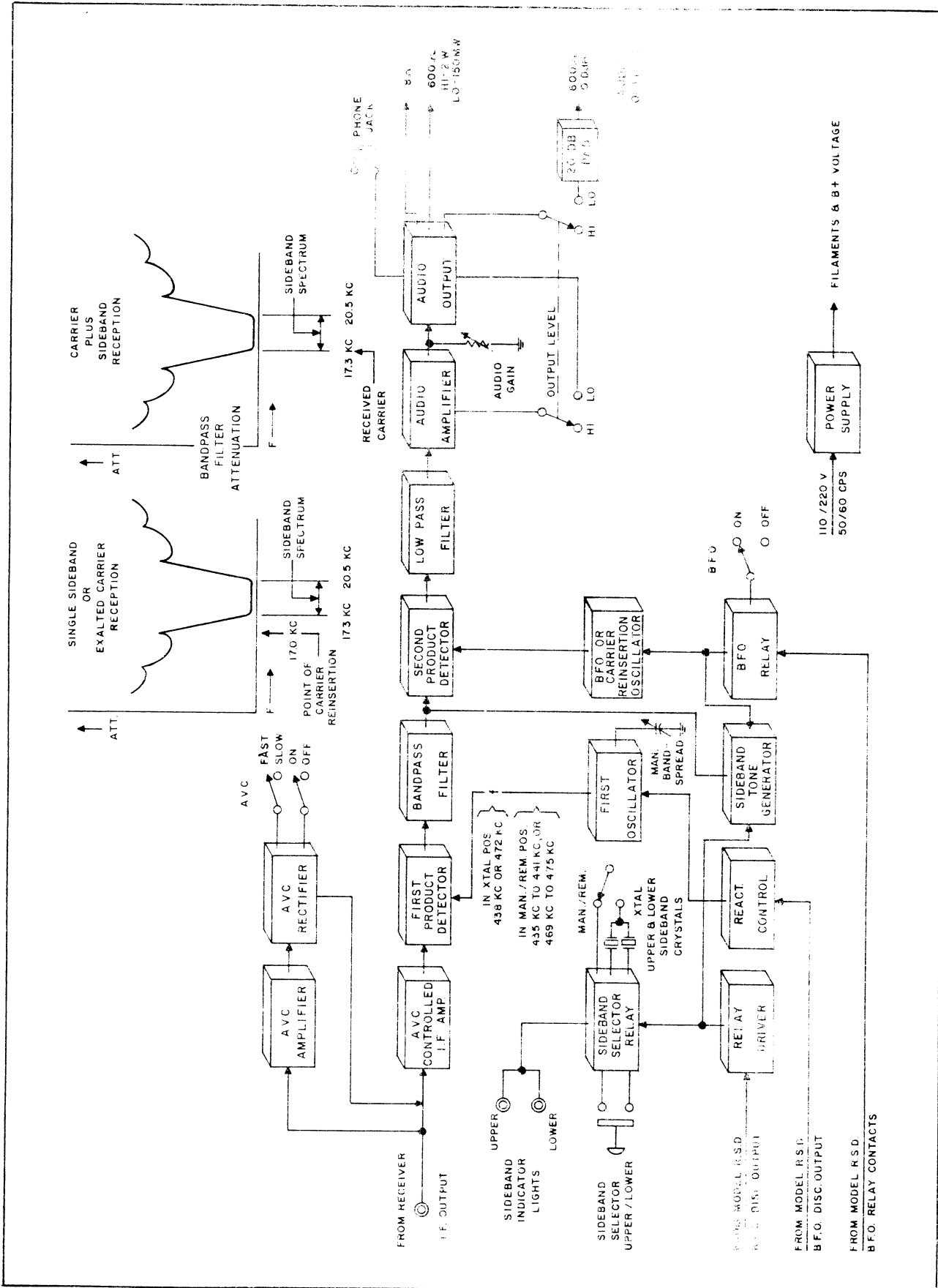

Figure 2-3. Block Diagram Model MSR



SECTION III INSTALLATION AND OPERATION

1. INSTALLATION

A. UNPACKING

The TMC Model MSR, Mode Selector, Receiving has been designed for ease of installation and minimum effort in operation. The unit is packed in an individual shipping container and should be carefully unpacked. A close visual inspection should be made to determine any physical damage due to rough handling during shipment. If damage is found notify carrier immediately.

B. POWER SUPPLY

The unit is designed for operation from 110 volts, 50/60 cycle source, unless specifically ordered for 220 volt, 50/60 cycles. The unit is shipped wired for 110 volt AC operation. A simple wiring change in the tapped primary circuit of the power transformer is necessary to change the Model MSR to 220 volt AC operation see Figure 5-5. This change is made directly on the power transformer terminal lugs as follows:

Remove switch lead from terminal 2 of T5 and connect it to terminal 3. Change fuse value to 1-1/2 amp. A three wire line cord (CA-385) which connects to J2 (rear of chassis) is supplied. The free end of this cable has a 2 prong male plug with a pigtail lead for grounding purposes. If the use of this ground lead is required, loosen one of the screws on the convenience outlet face plate and insert the spade lug under the screw head. Tighten the screw to secure the ground lead, and insert plug into outlet.

C. ELECTRICAL CONNECTIONS

The proper electrical connections are made at the rear of the chassis. A lowloss coaxial cable is required to connect the I. F. output of the receiver into the MSR. If no I. F. output jack is available on the receiver, the proper connection may be made at the plate of the last I. F. amplifier through a 47 mmfd capacitor.

The audio output connections are made on the rear apron at terminalstrip E1 or the chassis connector J4, for which a mating cable connector is supplied. Since three levels of output are available, the connections to P4 must be made as follows.

2 watt, 600 ohm output. Output Level switch in HIGH position.

- E1 Terminals 5 and 6.
OR
P4 Pins B and D

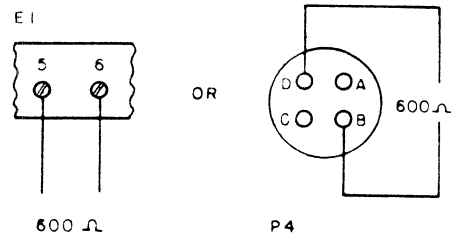

2 watt, 8 ohm output. Output Level switch in HIGH position.

- E1 Terminals 4 and 5.
OR
P4 Pins C and D.

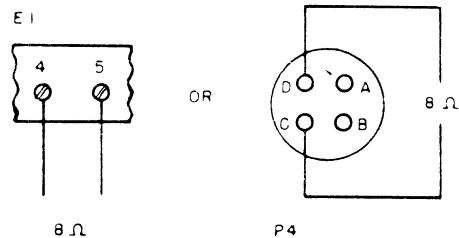

150 milliwatt, 600 ohm output. Output level switch in LOW position. Note position of jumper which is normally between terminals 1 and 3.

- E1 Terminals 5 and 6.
OR
P4 Pins B and D.

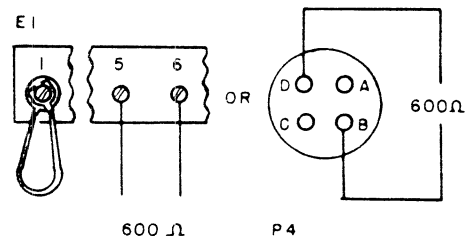

150 milliwatt, 8 ohm output. Output Level switch in LOW position. Note position of jumper which is normally between terminals 1 and 3.

- E1 Terminals 4 and 5.
 or
 P4 Pins C and D.

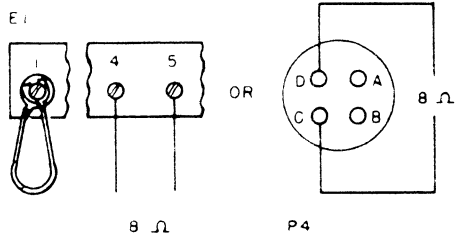

1 milliwatt, 600 ohm telephone line only. Output Level switch in LOW position. Note normal position of jumper.

- E1 Terminals 2 and 3.
 or
 P4 Pins A and D.

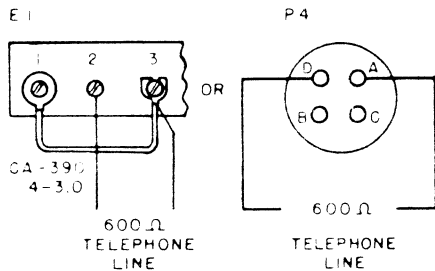

Simultaneous use of telephone line at 1 milliwatt, 600 ohms, or 8 ohm loudspeaker at 150 milliwatts. Note position of jumper.

- E1 600 ohm Terminals 2 and 3.
 8 ohm Terminals 4 and 5.
 or
 P4 600 ohm Pins A and D.
 E1 8 ohm Terminals 4 and 5.

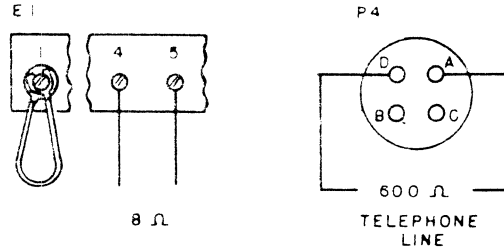
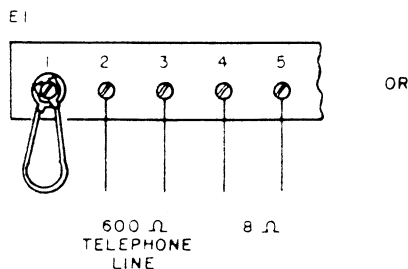

Single loudspeaker operation for both the MSR and the receiver is possible by paralleling the output connections of either the 600 ohm or loudspeaker tap. The output impedance has now been halved. Therefore, to match the impedance correctly it must be connected to the next higher impedance on the receiver. The output is then determined by the adjustment of the audio gain control on either unit. See Figure 3-1.

The control voltages for remote operation may be obtained from the TMC Model RCR, Remote Control Receiver System which controls the TMC Model FFR, Communication Receiver. The following leads are removed from the Model FFR and connected to the Model MSR.

See Figure 3-2 for proper cabling.

1. Remove the BFO relay leads on terminals 5 and 6 of E102 of the FFR and replace to terminals 9 and 10 of E1 of the MSR.
2. Remove the BFO control leads on terminals 7 and 8 of E102 of the FFR and connect to terminals 11 and 12 of E1 of the MSR.
3. A shielded lead is connected from terminal 3 of E102 of the FFR to terminal 8 of the MSR.

The audio return from the MSR at the remote site back to the control site is taken from pins A and D on P4, the one milliwatt level 600 ohm telephone line. The Output Level switch S8 must be in the LOW position.

When shipped, the Model MSR front panel sideband indicators are positioned as follows.

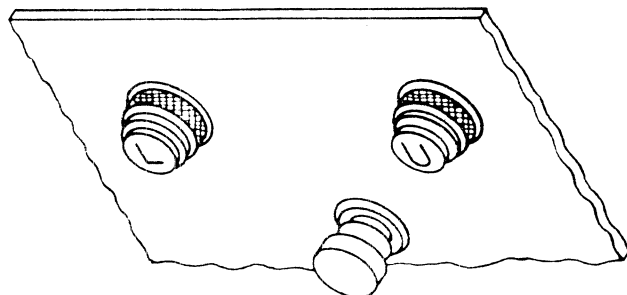

This position is for use with receivers which have a reversal of sidebands in the I. F. due to a conversion process where the oscillator frequency is above the R. F. signal. If a succeeding conversion process has the oscillator below the I. F., no change takes place in the sideband relationship.

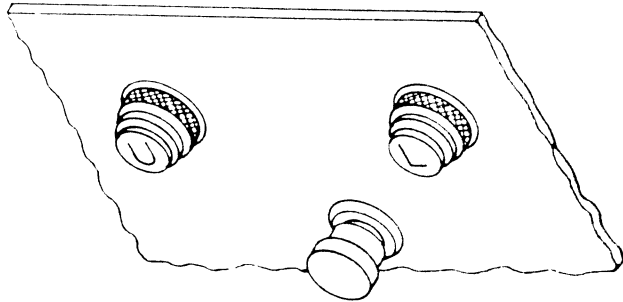

If, however, a second or third conversion oscillator frequency is above the I. F. a reversal of sideband positioning takes place. It then becomes necessary to reverse the sideband indicator jewels. Pull them out and replace as above.

2. OPERATION

A. DESCRIPTION OF CONTROLS

All operating controls are located on the front panel and perform similar functions to those found on any receiver.

BANDSPREAD - Tunes incoming signals across the band of the bandpass filter. Interfering signals are easily placed off the edge of the filter.

MANUAL/XTAL - The bandspread oscillator is variable either with the BANDSPREAD control or remotely when this switch is in MANUAL position. In XTAL position the oscillator is fixed to the frequency of the crystal within the unit.

UPPER/LOWER SIDEBAND - Either sideband is selected by pushing and releasing the button. A panel light indicates which sideband will pass through the filter. See Page 3-2 for correct placement of indicators.

BFO ON/OFF - This switch controls the second oscillator which reinserts the carrier for suppressed carrier operation or the tone for CW operation.

AVC ON/OFF - This switch permits control of signal either with or without carrier. For SSB, CW or FS signals the switch is set to SLOW. For AM or MCW signals the switch is set to FAST.

OUTPUT LEVEL CONTROL: (Rear deck). Control HIGH/LOW output level. Disconnects telephone lines when in HIGH position.

AUDIO GAIN - This control adjusts the output of the audio amplifier.

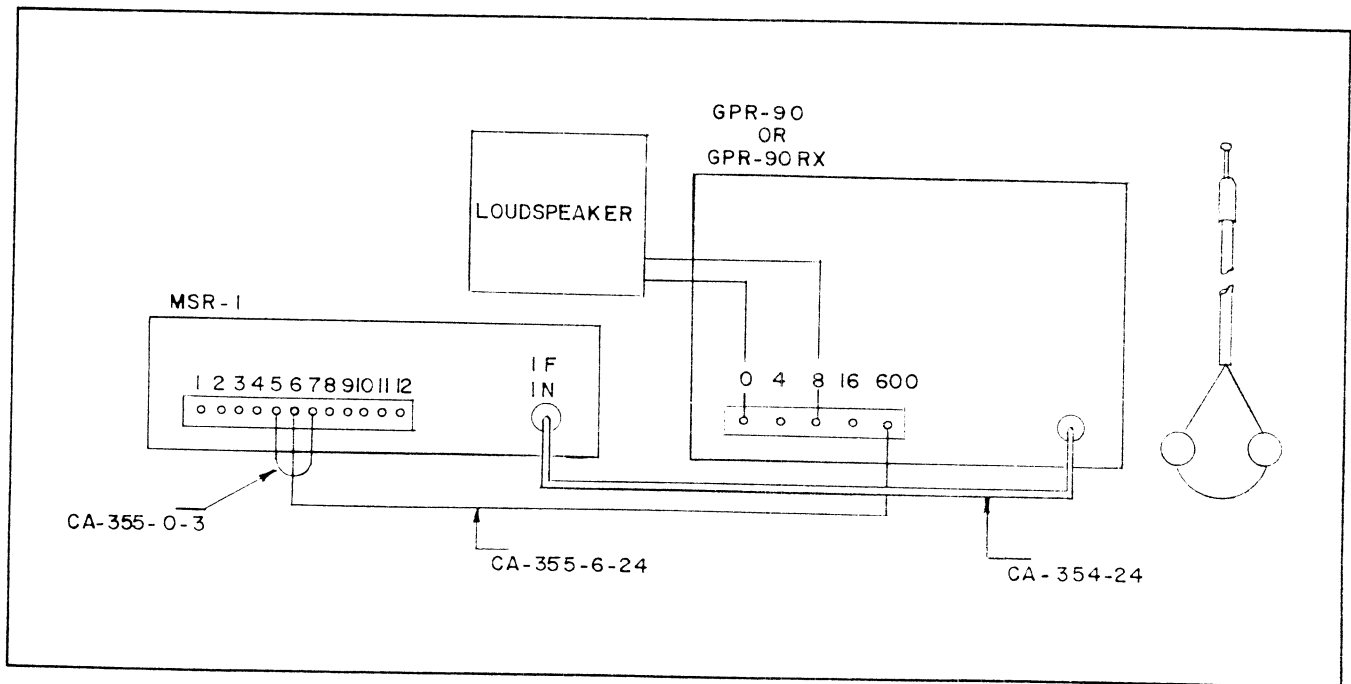

Figure 3-1. Cabling Connections Models MSR/GPR-90 for Single Loudspeaker Operation

45311

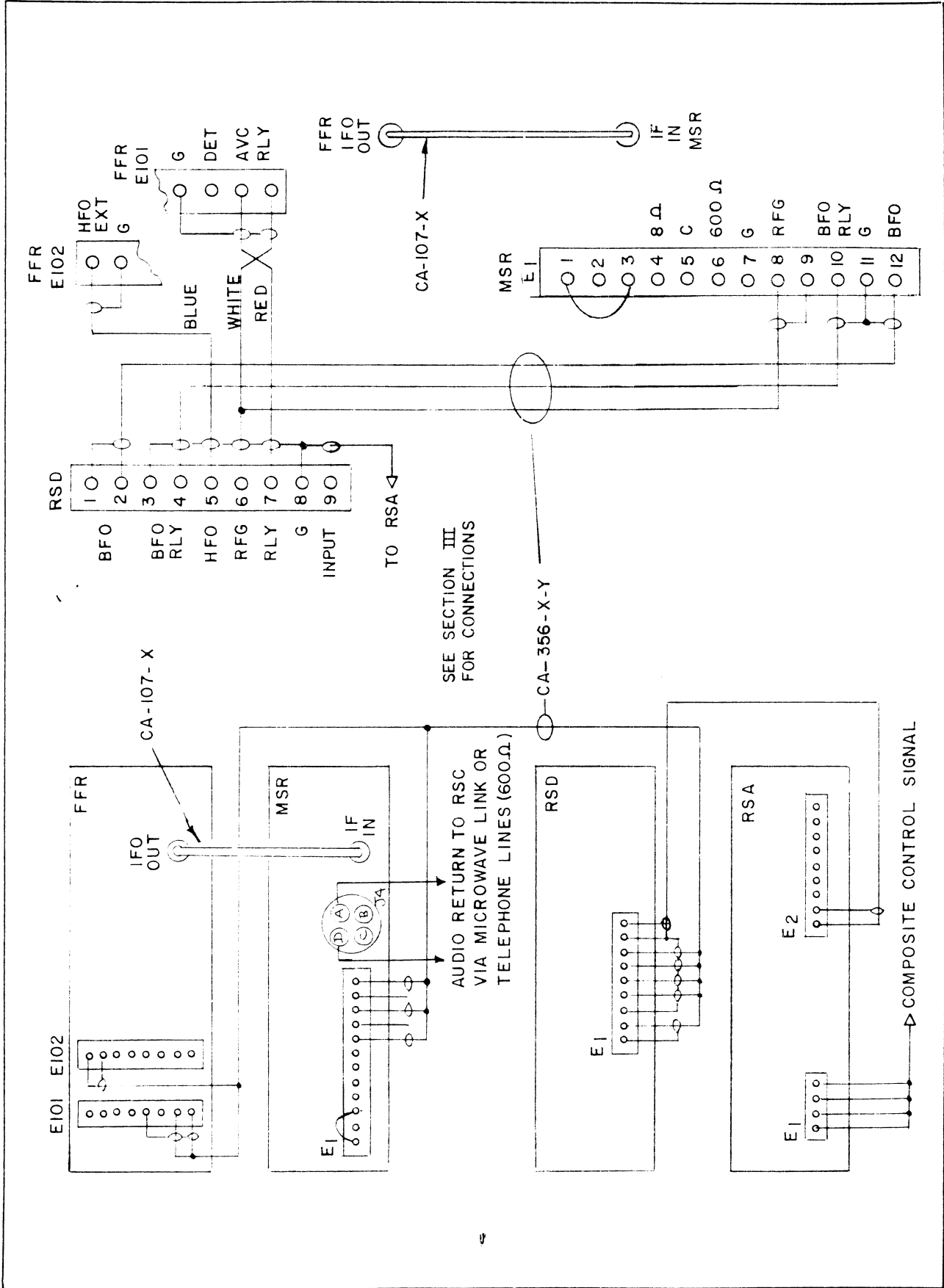

Figure 3-2. Cabling Connections Models MSR/FFR/RSD/RSA

85311

PHONES - This jack permits monitoring the audio output without cutting off the output.

POWER/OFF - This switch applies power to the unit.

B. TUNING PROCEDURE

(1) NORMAL TUNING OF RECEIVER TO SIGNAL FREQUENCY.

This method is used when the receiver bandwidth is sufficient to pass the sideband with no decrease of sideband amplitude. Employ the normal oscillator frequency equations as described in the receiver instruction manual (FFR or GPR-90) to tune the receiver to the signal frequency. If the receiver bandwidth is 5 kc or lower and the unimpaired passage of the desired sideband is required, then the receiver must be tuned off the signal frequency. This method is described in (2) below.

(a) Reception of Single Sideband Signals.

1. Tune receiver to signal frequency.
2. MSR and receiver AVC ON and SLOW.
3. MSR BFO switch ON.
4. MSR MANUAL/XTAL switch on MANUAL.
5. Upper Sideband reception.
 - a. MSR on UPPER.
 - b. Tune MSR BANDSPREAD control to zero center position for intelligibility.
 - c. For crystal operation set MANUAL/XTAL switch on XTAL and place a 472 kc crystal in socket Y2.
6. Lower Sideband reception.
 - a. MSR set on LOWER.
 - b. Tune MSR BANDSPREAD control to zero center for intelligibility.
 - c. For crystal operation set MANUAL/XTAL switch on XTAL and place a 438 kc crystal in socket Y2. Tune receiver for intelligibility.

(b) Reception of AM Signals.

1. Tune receiver to signal frequency.
2. MSR and receiver AVC ON and FAST.
3. MSR BFO switch OFF.
4. MSR MANUAL/XTAL switch on MANUAL.
5. Reception of both sidebands.
 - a. MSR set on UPPER.
 - b. Tune MSR BANDSPREAD control +2 kc above zero center.
 - c. For crystal operation use a 474 kc crystal in socket Y2 with MANUAL/XTAL switch on XTAL.

6. Reception of Upper Sideband.
 - a. MSR set on UPPER, MANUAL/XTAL switch on MANUAL.
 - b. Tune MSR BANDSPREAD control +.4 kc above zero center.
 - c. Xtal operation use a 472 kc crystal in socket Y2 with MANUAL/XTAL switch on XTAL. Retune receiver .4 kc below the signal frequency. If receiver is crystal controlled pull the crystal frequency approximately 400 cps. with the crystal adjust control.
7. Reception of Lower Sideband.
 - a. MSR set on LOWER, MANUAL/XTAL switch on MANUAL.
 - b. Tune MSR Bandsread control -.4 kc below zero center.
 - c. Xtal operation use a 438 kc crystal in socket Y1 with MANUAL/XTAL switch set on XTAL. Retune receiver .4 kc above the signal frequency. If receiver is crystal controlled pull the crystal frequency approximately 400 cps with the crystal adjust control.

(c) Exalted Carrier Operation.

1. Tune receiver to signal frequency.
2. MSR and receiver AVC ON and FAST.
3. MSR BFO switch ON.
4. MSR MANUAL/XTAL switch on MANUAL.
5. Tune MSR as for SSB.

(d) CW and FS Operation.

1. Tune receiver to signal frequency.
2. MSR and receiver AVC ON and SLOW.
3. MSR BFO switch to ON.
4. MSR MANUAL/XTAL switch on MANUAL.
5. Tune MSR BANDSPREAD control to obtain desired pitch of signal.
6. Crystal operation - with MSR set on UPPER and MANUAL/XTAL switch set on XTAL, use a 474 kc crystal in socket Y2 for a 2 kc CW note. Tune receiver for any other desired beat note.

(2) OFF CENTER TUNING OF RECEIVER.

Off center tuning of receiver to increase receiver bandwidth to sideband reception. This method will permit the maximum bandwidth of the system to pass the sideband of the desired signal in the I. F. passband by detuning the receiver 2 kc in the appropriate direction, above the signal fre-

quency for the upper sideband and below the signal frequency for the lower sideband. The MSR must also be adjusted accordingly to realign the signal. The correct method follows:

(a) Reception of Single Sideband Signals.

1. MSR and receiver AVC ON and SLOW.
2. MSR BFO switch ON.
3. MANUAL/XTAL switch on MANUAL.
4. Upper Sideband Reception.
 - a. Tune receiver 2 kc above signal frequency.
 - b. Tune MSR BANDSPREAD control +2 kc above zero center for intelligibility.
 - c. Crystal operation - set MANUAL/XTAL switch on XTAL and place a 474 kc crystal in socket Y2. Tune receiver for intelligibility.
5. Lower Sideband Reception.
 - a. Tune receiver -2 kc below signal frequency.
 - b. Tune MSR BANDSPREAD control to -2 kc below zero center for intelligibility.
 - c. For crystal operation set MANUAL/XTAL switch on XTAL and place a 436 kc crystal in socket Y1. Tune receiver for intelligibility.

(b) Reception of AM Signals.

1. MSR and receiver AVC ON and FAST.
2. MSR BFO switch OFF.
3. MSR MANUAL/XTAL switch on MANUAL.
4. Reception of Upper Sideband.
 - a. Tune receiver 1.6 kc above signal frequency.
 - b. MSR set on UPPER.
 - c. Tune MSR BANDSPREAD control +2 kc above zero center.
 - d. For Xtal operation place MANUAL/XTAL switch on XTAL and insert a 474 kc crystal in socket Y2. Retune receiver 1.6 kc above the signal frequency.
5. Reception of Lower Sideband.
 - a. Tune receiver 1.6 kc below signal frequency.
 - b. MSR set on LOWER.
 - c. Tune MSR BANDSPREAD control -2 kc below zero center.
 - d. For Xtal operation place MANUAL/XTAL switch on XTAL and insert a 436 kc crystal in socket Y1. Retune receiver 1.6 kc below the signal frequency.

(c) Exalted Carrier Operation.

1. MSR and receiver AVC ON and SLOW.
2. MSR BFO switch ON.
3. Reception of sidebands. See B-(2) - (a) above.

3. REMOTE OPERATION

A. FUNCTIONS.

The TMC Model RCR Remote Control Receiver System will control the MSR in conjunction with the TMC Model FFR communication Receiver in a remote installation.

The HFO control on the RSC tunes the HFO of the FFR within a limited range. There is no change of its function or range.

With the RSC's AVC switch ON, the FFR gain is being controlled by its own AVC. With the RCS's AVC switch OFF, the RF GAIN control determines not only the gain of the FFR but with proper manipulation operates the MSR sideband selector and indicates proper sideband.

The MSR sideband selector is operated as follows:

- (1) Turn RSC AVC switch to OFF.
- (2) Turn RF GAIN control fully clockwise to 10. This advances the switching relay to the next sideband.
- (3) Turn RF GAIN control fully counter-clockwise to zero and hold for one second. This releases the sideband switching relay. Switching is now completed.
- (4) Return control to normal position for desired gain.

The sideband in use is indicated in the loudspeaker as an audible tone; low pitch for lower sideband, high pitch for upper sideband. If the sidebands have been reversed according to Page 3-2 the Sideband Tone Generator must also be adjusted to produce the correct tone. See Page 4-2. The tone becomes audible as the RF GAIN is turned clockwise past 5. The tone increases in volume as the control is advanced until the switching sequence is performed. The tone changes pitch as soon as the switching occurs. Returning the control to zero removes the tone.

B. REMOTE TUNING

Remote operation of the MSR in the RCR System requires that the RSC, MSR and FFR be aligned correctly to the desired signal. In setting up the system, the methods described in the RCR instruction manual are followed, keeping

in mind, the functions of the various controls on the RSC which operate the MSR. When it is determined that the RCR system is operating correctly, align the RSC, MSR and FFR to receive the desired signal. At the control site set the RSC control as follows:

- HFO control - Centered at 0
- BFO switch - ON
- BFO control - Centered at 0
- AVC switch - ON

At the remote site, tune the MSR and the FFR receiver as described in the tuning procedure. Once the receiver is tuned, lock its tuning dial in position. Control of the equipment is now returned to the control site.

At the control site, the RSC controls now perform the functions as described in Functions Part A above. When receiving AM signals, the MSR BANDSPREAD control is inoperative since the BFO switch is OFF. Operation of the HFO control is required to tune the desired AM signal into the MSR.



SECTION IV MAINTENANCE

1. SERVICE MAINTENANCE

A. GENERAL

The Model MSR has been designed for long term trouble free duty. Little attention beyond normal maintenance is required. It is recommended that any maintenance to the equipment be performed by a competent technician.

Should normal operation procedure produce unsatisfactory results, a quick check of the power supply will very often determine the cause of the trouble. A pilot light indicates when power is being applied to the unit. Should the pilot lamp fail to light then the UPPER/LOWER SIDEBAND switch should be operated as an alternate means of checking since the sideband switching relay operates directly off of the 110 volt line. If no power is evident then check the fuse on the rear apron. A blown fuse should be replaced with one of equal value. If the fuse blows again the unit should be checked for shorts. The most common cause of operational failure is usually tube failure. Checking the tubes will often save many hours of unnecessary troubleshooting.

B. PREVENTIVE

All components in this unit have been carefully selected to assure maximum efficiency in operation. If the sensitivity should drop and tube failure is suspected, test each tube in a reliable tube tester. The measured characteristics of the tube should be within the manufacturers tolerances (usually $\pm 20\%$ from tube manual tolerances). No special selection is necessary in the event of tube replacement, but the operator should remember that tubes of the same type will vary slightly in their individual characteristics.

Failure may occur due to breakdown of capacitors or resistors. Test all AC and DC voltages as indicated on Tube Voltage and Resistance charts, and investigate any serious discrepancies.

A faulty capacitor may cause overload of associated resistors, which should be checked for any change in resistance value. A shorted resistor may be detected by scorching or discoloration marks on the surface of the resistor. An open capacitor may cause unwanted oscillations and may be checked by connecting a good capacitor across it.

In order to prevent failure of the equipment due to corrosion, dust, and other destructive ambient conditions, it is recommended that the inside of the chassis be thoroughly inspected for signs of dirt, dampness, molding, charring or corrosion every 6 months. Correct any defect with cleaning agent of proven quality. When placing the unit in the rack, the operator should make certain that all terminal screw connections are tight.

2. CIRCUIT ALIGNMENT

The oscillators have been aligned to their correct frequencies at the factory. Readjustment will only be required if the performance of the unit is impaired as when the bandspread oscillator is off scale with a signal centered on 455 kc. The oscillators may be aligned either with an accurate signal generator or with a receiver as the signal source.

A. ALIGNMENT WITH SIGNAL GENERATOR.

Equipment Required

RF Signal Generator
Audio Generator
Vacuum Tube Volt Meter
Oscilloscope
DC Source 0 to ± 10 volts.

1. Alignment of Bandspread Oscillator-Upper Sideband.
 - a. Feed a 472.00 kc signal from the RF signal generator to the IF input jack J1.
 - b. Connect the oscilloscope to pin 5 of V3 the 1st Mixer.
 - c. Switch sideband to UPPER.
 - d. To assure a zero potential at terminal 12 of E1, short terminals 11 and 12.
 - e. Set BANDSPREAD control to zero.
 - f. Adjust the core of T2 for a zero beat on scope (steady horizontal trace).
2. Alignment of Bandspread Oscillator-Lower Sideband.
 - a. Switch sideband to LOWER.
 - b. Set RF signal generator to 438.00 kc.
 - c. Adjust C29 for a zero beat on scope (steady horizontal trace).
 - d. Remove short from terminals 11 and 12 of E1.

TUBE	TYPE	FUNCTION	SOCKET PIN NUMBERS								
			1	2	3	4	5	6	7	8	9
V1	12AU7	AVC AMP.-RECT.	- 0.6	-0.6	0.4	6.3*	6.3*	104	0	2.3	6.3*
V2	6BA6	I.F. AMP.	0	2.8	6.3*	6.3*	140	110	2.8		
V3	6BE6	1st MIXER	-11.2	2.2	6.3*	6.3*	255	66	0		
V4	6BE6	2nd MIXER	-4	0.7	6.3*	6.3*	148	75	0		
V5	12AT7	2nd OSC -AUD. AMP.	104	-13	0	6.3*	6.3*	68	0	0.7	6.3*
V6	6AQ5	AUDIO OUT.	NC	19	6.3*	6.3*	300	300	0		
V7	6AG5	1st OSC.	-1.7	0.44	6.3*	6.3*	60	83	NC		
V8	6J6	REACT. MOD.	60	60	6.3*	6.3*	0	0	1.8		
V9	12AU7	RELAY DRIVER-SIDE TONE GEN.	60	0	1.4	6.3*	6.3*	148	30	58	6.3*
V10	5Y3	RECTIFIER	NC	365	NC	365*	NC	365*	NC	365	
V11	OA2	VOLT. REG.	150	NC	NC	NC	150	NC	0		

CONDITIONS:
 All measurements taken with V.T.V.M.
 BFO - ON
 Sideband - Manual
 Audio Gain - Clockwise
 AVC - Off
 No Signal

NC = No Connection
 * = AC Voltage

AC Line Voltage - 115 V.
 All to ground except AC
 Filament Voltages - Across Filaments

CH-161

Figure 4-1. Voltage Chart Model MSR

3. Bandsread Oscillator Remote Control.
 - a. Connect the variable DC supply to terminal 12 of E1.
 - b. Varying the DC voltage ± 4.5 volts should produce a balanced shift of approximately ± 4 kc in either upper or lower sideband position. If not reasonably balanced, adjust Reactance Balance Control, R48 for proper balance.
4. Alignment of 17 kc Oscillator.
 - a. Feed a 17.00 kc audio signal to pin 7 of V4 the 2nd Mixer.
 - b. Connect the scope to pin 5 of V4.
 - c. Set the BFO switch to ON.
 - d. Adjust the C40 (mounted on top of Z4) for a zero beat on the scope.
5. Sideband Selector Remote Operation.
 - a. Connect the variable DC source to terminals 7 and 8 of E1 with negative lead on 8.
 - b. Vary the DC voltage from zero to -9.0 volts. Switching should occur

- between -7.5 and -8.0 volts. If not adjust R54 accordingly.
6. Alignment of Side Tone Generator.
 - a. Set BFO switch to ON.
 - b. Connect the VTVM to pin 7 of V4.
 - c. Vary the DC supply connected to pins 7 and 8 of E1 from zero to -9.0 volts. As the DC voltage approaches -5.0 volts the side tone oscillator should just start. Decreasing the voltage to -9.0 volts should increase the output of the oscillation to approximately 2.5 volts.

NOTE: Oscillator will start at two positions of threshold. Correct position produces increased output as control voltage goes more negative.

- d. Set sideband to LOWER.
- e. Adjust C55 on Z5 for 500 cps note.
- f. Set sideband to UPPER.
- g. Output frequency will be approximately 2.5 kcs.

TUBE	TYPE	FUNCTION	SOCKET PIN NUMBERS								
			1	2	3	4	5	6	7	8	9
V1	12AU7	AVC AMP.-RECT.	1.2M	1.2M	150K	0	0	80K	430K	470	0
V2	6BA6	I.F. AMP.	470K	330	0	0	66K	100K	330		
V3	6BE6	1st MIXER	22K	220	0	0	50K	63K	470K		
V4	6BE6	2nd MIXER	9	120	0	0	150K	90K	20K		
V5	12AT7	2nd OSC.-AUD. AMP.	inf.	100K	1.2	0	0	140K	1.0M	390	0
V6	6AQ5	AUDIO OUT.	NC	560	0	0	38K	38K	470K		
V7	6AG5	1st OSC.	22K	120	0	0	72K	72K	NC		
V8	6J6	REACT. MOD.	90K	90K	0	0	590K	33K	1.5K		
V9	12AU7	RELAY DRIVER-SIDE TONE GEN.	52K	1 M	390	0	0	inf.	220K	30K	0
V10	5Y3	RECTIFIER	NC	38K	NC	100	NC	100	NC	38K	
V11	OA2	VOLT. REG.	38K	NC	NC	NC	38K	NC	0		

CONDITIONS:

Ohmmeter - Simpson 260 or Equivalent
Resistances to Ground
Audio Gain - Clockwise
Manual/Xtal - Manual
Power - Off
AVC - Off
BFO - On

NC = No Connection
K = Thousand
M = Million

CH-160

Figure 4-2. Resistance Chart Model MSR

7. When the sidebands are reversed as explained on Page 3-6 the above procedure is reversed as shown below.
 - d. Set sideband to UPPER.
 - e. Adjust C55 on Z5 for 500 cps note.
 - f. Set sideband to LOWER.
 - g. Output frequency will be approximately 2.5 kcs.

B. ALIGNMENT WITH RECEIVER

Tune in a stable signal so that its carrier passes through the center of the IF. If the receiver has a selective IF filter, it should be used in its narrowest position to determine correct placement of the carrier on 455 kc. Place the

sideband oscillator of the MSR in the XTAL position at either 472 kc or 438 kc.

- (1) Set BFO to ON.
- (2) Tune 17 kc oscillator (C40) to obtain a zero beat.
- (3) Set BANDSPREAD control to zero.
- (4) Set sideband to UPPER.
- (5) Switch from XTAL to MANUAL.
- (6) Adjust T2 of Z3 to obtain a zero beat.
- (7) Set sideband to LOWER.
- (8) Adjust C29 to obtain zero beat.

The side tone generator is checked as in A (6) above since no input signal is required.



SECTION V
ELECTRICAL PARTS LIST

SYM.	DESCRIPTION	FUNCTION	TMC DWG OR PT. NO.
C1	CAPACITOR, fixed: ceramic; .01 mfd, +80%-20%; 500 wvdc.	IF Input Coupling	CC-100-16
C2	CAPACITOR, fixed: ceramic; .01 mfd, +80%-20%; 500 wvdc. (Same as C1)	AVC Blocking Cap., V1A	CC-100-16
C3	CAPACITOR, fixed: ceramic; .01 mfd, +80%-20%; 500 wvdc. (Same as C1)	Plate Bypass Cap., V2	CC-100-16
C4	CAPACITOR, fixed: ceramic; .01 mfd, +80%-20%; 500 wvdc. (Same as C1)	Cath. Bypass V1A	CC-100-16
C5	CAPACITOR, fixed: ceramic; .01 mfd, +80%-20%; 500 wvdc. (Same as C1)	Screen Bypass V2	CC-100-16
C6	CAPACITOR, fixed: ceramic; 120 mmfd, ±24 uuf; 500 wvdc.	Coupling Cap., V2-V3	CC-101-4
C7	CAPACITOR, fixed: ceramic; 47 mmfd, ±10%; 500 wvdc.	Coupling Cap., V3-V8	CC21SL470K
C8	CAPACITOR, fixed: ceramic; .01 mfd, +80%-20%; 500 wvdc. (Same as C1)	Plate Bypass Cap., V3	CC-100-16
C9	CAPACITOR, fixed: plastic; .01 mfd, +40%-10%; 400 wvdc.	Coupling Cap., V1A-V1B	CN-100-1
C10	CAPACITOR, fixed: ceramic; .01 mfd, +80%-20%; 500 wvdc. (Same as C1)	Plate Decoupl. Cap., V1A	CC-100-16
C11	CAPACITOR, fixed: ceramic; .01 mfd, +80%-20%; 500 wvdc. (Same as C1)	Cath. Bypass Cap., V3	CC-100-16
C12	CAPACITOR, fixed: ceramic; .01 mfd, +80%-20%; 500 wvdc. (Same as C1)	Screen Bypass Cap., V3	CC-100-16
C13	CAPACITOR, fixed: ceramic; .001 mfd, ±200 uufd; 500 wvdc.	Plate Bypass Cap., V1B	CC-100-9
C14	CAPACITOR, fixed: plastic; .1 mfd, ±5%; 200 wvdc.	AVC Filter Cap., V1B	CN108C1003J
C15	CAPACITOR, fixed: ceramic; 47 mmfd, ±10%; 500 wvdc. (Same as C7)	Coupling Cap., V4-V10	CC21SL470K
C16	CAPACITOR, fixed: ceramic; 82 mmfd, ±5%; 500 wvdc.	Coupling Cap., V4	CC26SL820J
C17	CAPACITOR, fixed: ceramic; .01 mfd, +80%-20%; 500 wvdc. (Same as C1)	Plate Bypass Cap., V4	CC-100-16
C18	CAPACITOR, fixed: ceramic; .01 mfd, +80%-20%; 500 wvdc. (Same as C1)	Cath. Bypass Cap., V4	CC-100-16

SYM.	DESCRIPTION	FUNCTION	TMC DWG OR PT. NO.
C19	CAPACITOR, fixed: ceramic; .01 mfd, +80%-20%; 500 wvdc. (Same as C1)	Screen Bypass Cap., V4	CC-100-16
C20	CAPACITOR, fixed: ceramic; .01 mfd, +40%-10%; 400 wvdc. (Same as C9)	Coupling Cap., V4-V5	CN-100-1
C21	Not Used.		
C22	Not Used.		
C23	CAPACITOR, fixed: ceramic; 0.1 ufd, +40%-10%; 400 wvdc.	Feedback Cap., V5B	CN-100-4
C24	CAPACITOR, fixed: ceramic; .01 mfd, +40%-10%; 400 wvdc. (Same as C9)	Coupling Cap., V6B-7	CN-100-1
C25	CAPACITOR, fixed: plastic; 2 mfd, ±10%; 200 wvdc.	Cath. Bypass Cap., V7	CN108C2004K
C26	CAPACITOR, fixed: ceramic; .001 mfd, +200 uufd; 500 wvdc. (Same as C13)	Audio Bypass Cap., V7	CC-100-9
C27	CAPACITOR, fixed: electrolytic; 10 mfd, 300 wvdc.	P.S. Filter Cap., V7	CE64C100N
C28	CAPACITOR, variable: air; 2.8-16 mmfd, 1200 v RMS.	Bandspread	CB-135-4
C29	CAPACITOR, variable: ceramic; 7-45 mfd, 500 wvdc.	Bandspread Adj. Cap.	CV11C450
C30	CAPACITOR, fixed: ceramic; 100 mmfd, ±5%; 500 wvdc.	Coupling Cap., V9	CC32CH101J
C31	CAPACITOR, fixed: mica; 51 uufd, ±5%; 500 wvdc.	Bandspread Comp. Cap.	CM20E510J
C32	CAPACITOR, fixed: mica; 430 mmfd, ±2%; 500 wvdc.	p/o Bandpass Filter, Z3	CM20D431G
C33	CAPACITOR, fixed: ceramic; 47 mmfd, ±5%; 500 wvdc.	Coupling Cap., S4	CC32CH470J
C34	CAPACITOR, fixed: ceramic; 30 mmfd, ±5%; 500 wvdc.	Grid Bypass Cap., S4	CC21SL300J
C35	CAPACITOR, fixed: ceramic; .01 mfd, +80%-20%; 500 wvdc. (Same as C1)	Cath. Bypass Cap., V8	CC-100-16
C36	CAPACITOR, fixed: ceramic; .01 mfd, +80%-20%; 500 wvdc. (Same as C1)	Screen Bypass Cap., V8	CC-100-16
C37	CAPACITOR, fixed: ceramic; 150 mmfd, ±10%; 500 wvdc.	Screen Bypass Cap., V8	CC-101-2
C38	CAPACITOR, fixed: mica; .001 mfd, ±2%; 500 wvdc.	p/o 17 kc Osc. Tank, Z4	CM20D102G

SYM.	DESCRIPTION	FUNCTION	TMC DWG OR PT NO.
C39	CAPACITOR, fixed: mica; 1500 mmfd, ±2%; 500 wvdc.	p/o 17 kc Osc. Tank, Z4	CM20D152G
C40	CAPACITOR, variable: mica; 100-550 mmfd, 250 wvdc.	17 kc Osc. Adj., Z4	CV-100-304
C41	Not Used.		
C42	CAPACITOR, fixed: plastic; .1 mfd, ±5%; 200 wvdc. (Same as C14)	Filter Cap., V9	CN108C1003J
C43	CAPACITOR, fixed: plastic; .1 mfd, ±5%; 200 wvdc. (Same as C14)	Filter Cap., V9	CN108C1003J
C44	CAPACITOR, fixed: ceramic; .001 mfd, ±200 uuf; 500 wvdc. (Same as C13)	Plate Coupling Cap., V9	CC-100-9
C45	CAPACITOR, fixed: ceramic; 22 mmfd, ±5%; 500 wvdc.	Screen Bypass Cap., V9	CC21SL220J
C46	CAPACITOR, fixed: ceramic; .005 mfd, G.M.V.: 500 wvdc.	Cath. Bypass Cap., V9	CC-100-15
C47 A,B	CAPACITOR, fixed: ceramic; two section; .01 mfd, 500 wvdc each section.	AC Line Filter Cap.	CC-100-23
C48	CAPACITOR, fixed: paper; 4 mfd, +20% -10%, 600 wvdc.	PS Filter Cap., V11	CP41B1FF405V
C49 A,B	CAPACITOR, electrolytic: 35 - 35 mfd.	PS Filter Cap., V11	CE52F350R
C50	CAPACITOR, fixed: mica; .001 mfd, ±2%; 500 wvdc. (Same as C38)	p/o 17 kc Osc. Tank, Z4	CM20D102G
C51	CAPACITOR, fixed: mica; 8100 mmfd, ±2%; 500 wvdc.	Grid Bypass Cap., V4	CM20D812G
C52	CAPACITOR, fixed: mica; .001 mfd, ±2%; 500 wvdc. (Same as C38)	Grid Coupling Cap., V10B	CM20D102G
C53	CAPACITOR, fixed: mica; 820 mmfd, ±2%; 500 wvdc.	p/o Side Tone Gen. Tank, Z5	CM20D821G
C54	CAPACITOR, fixed: ceramic; .01 mfd, +80%-20%; 500 wvdc. (Same as C1)	Bypass Cap., Z5	CC-100-16
C55	CAPACITOR, variable: mica; 100-550 mmfd, 250 wvdc.	Side Tone Gen. Adj., Z5	CV-100-306
C56	CAPACITOR, fixed: ceramic; .01 mfd, +40%-10%; 400 wvdc. (Same as C9)	Coupling Cap., V3	CN-100-1
C57	CAPACITOR, fixed: ceramic; .01 ufd, +80%-20%; 500 wvdc. (Same as C1)	PS Filter Cap., V11	CC-100-16

SYM.	DESCRIPTION	FUNCTION	TMC DWG OR PT NO.
E1	TERMINAL BOARD, barrier type: plastic; 12 terminals, screw w/feed thru solder lug type.	Input Term. Board	TM-100-12
E2	TERMINAL BOARD, barrier type: plastic; 8 terminals, screw w/feed thru solder lug type.	Inter. Term. Board	TM-100-8
E4	TERMINAL BOARD, phenolic: 12 terminals, right angle spade lug type (supplied as loose item).	Fanning Strip	TM-105-12-AL
F1	FUSE, cartridge: 3 amp; 250 v; instantaneous.	Line Fuse	FU-100-3
I1	LAMP, incandescent: 6-8 v; 150 ma; T-3-1/4 clear bulb; bayonet base.	Sideband Indicator	BI-101-47
I2	LAMP, incandescent: 6-8 v; 150 ma; T-3-1/4 clear bulb; bayonet base. (Same as I1)	Sideband Indicator	BI-101-47
I3	LAMP, incandescent: 6-8 v; 150 ma; T-3-1/4 clear bulb; bayonet base. (Same as I1)	Power Indicator	BI-101-47
J1	CONNECTOR, receptacle: electrical; 1 female contact; 52 ohms; BNC type.	IF Input Jack	UG-625/U
J2	CONNECTOR, receptacle: electrical; 3 contacts, male.	AC Line Input Jack	MS3102A-16S-5P
J3	JACK, telephone: tip and sleeve; bushing mounted; fits plug PJ-055.	Phones Jack	JJ-034
J4	CONNECTOR, electrical: 4 contacts, male.	Audio Output	MS3102A-14S-2P
K1	RELAY, armature: DPDT; 80 vdc, 32 w; 20,000 ohms.	BFO Relay	RL-105
K2	RELAY, armature: impulse type; 4 PDT; 115 vac; 60 cps.	Sideband Selector Relay	RL-118-17A115-60-A
K3	RELAY, armature: DPDT; 80 vdc, 32 w; 20,000 ohms, (Same as K1)	Side Tone Selector Relay	RL-105
L1	REACTOR, fixed: 15 henries; 85 ma dc; 285 ohms dc; 2500 v RMS test.	PS Filter Choke, V11	TF-5000
L2	REACTOR, fixed: 15 henries; 85 ma dc; 285 ohms dc; 2500 v RMS test. (Same as L1)	PS Filter Choke, V11	TF-5000

SYM.	DESCRIPTION	FUNCTION	TMC DWG. OR PT NO.
P2	CONNECTOR, plug: electrical; 4 contacts, female. (Supplied as loose item)	Output	MS3106A-16S-5S
P4	CONNECTOR, plug: electrical; 4 contacts, female. (Supplied as loose item)	Input Plug	MS3106A-14S-2S
R1	RESISTOR, fixed: composition; 100,000 ohms, $\pm 10\%$; 1/2 w.	Grid Limiting Res., V2	RC20GF104K
R2	RESISTOR, fixed: composition; 470,000 ohms, $\pm 10\%$; 1/2 w.	Grid Res., V1A	RC20GF474K
R3	RESISTOR, fixed: composition; 100,000 ohms, $\pm 10\%$; 1/2 watt.	Grid Res., V2	RC20GF104K
R4	RESISTOR, fixed: composition; 22,000 ohms, $\pm 10\%$; 1 watt.	Plate Load Res., V2	RC30GF223K
R5	RESISTOR, fixed: composition; 330 ohms, $\pm 10\%$; 1/2 watt.	Cath. Bias Res., V2	RC20GF331K
R6	RESISTOR, fixed: composition; 68,000 ohms, $\pm 10\%$; 1 watt.	Screen Grid Res., V2	RC30GF683K
R7	RESISTOR, fixed: composition; 470 ohms, $\pm 10\%$; 1/2 watt.	Cath. Bias Res., V1A	RC20GF471K
R8	RESISTOR, fixed: composition; 2200 ohms, $\pm 10\%$; 1/2 watt.	Plate Decoupl. Res., V2	RC20GF222K
R9	RESISTOR, fixed: composition; 470,000 ohms, $\pm 10\%$; 1/2 watt.	Grid Res., V3	RC20GF474K
R10	RESISTOR, fixed: composition; 22,000 ohms, $\pm 10\%$; 1 watt. (Same as R4)	Plate Load Res., V1A	RC30GF223K
R11	RESISTOR, fixed: composition; 22,000 ohms, $\pm 10\%$; 1 watt. (Same as R4)	Plate Decoupl. Res., V1A	RC30GF223K
R12	RESISTOR, fixed: composition; 22,000 ohms, $\pm 10\%$; 1/2 watt.	Grid Res., V1B	RC20GF223K
R13	RESISTOR, fixed: composition; 150,000 ohms, $\pm 10\%$; 1/2 watt.	Cath. Bias Res., V1B	RC20GF154K
R14	RESISTOR, fixed: composition; 10,000 ohms, $\pm 10\%$; 1/2 watt.	Plate Load Res., V3	RC20GF103K
R15	RESISTOR, fixed: composition; 220 ohms, $\pm 10\%$; 1/2 watt.	Cath. Bias Res., V3	RC20GF221K
R16	RESISTOR, fixed: composition; 2200 ohms, $\pm 10\%$; 1/2 watt.	Plate Decoupl. Res., V3	RC20GF222K
R17	RESISTOR, fixed: composition; 1.5 megohm, $\pm 10\%$; 1/2 watt.	AVC Load Res., V1B	RC20GF155K

SYM.	DESCRIPTION	FUNCTION	TMC DWG OR PT NO.
R18	RESISTOR, fixed: composition; 10 megohms, $\pm 10\%$; 1/2 watt.	AVC Time Constant Cap.	RC20GF106K
R19	RESISTOR, fixed: composition; 20,000 ohms, $\pm 5\%$; 1/2 watt.	Grid Res., V4	RC20GF203J
R20	RESISTOR, fixed: composition; 100,000 ohms, $\pm 10\%$; 1/2 watt.	Grid Res., V4	RC20GF104K
R21	RESISTOR, fixed: composition; 20,000 ohms, $\pm 5\%$; 1/2 watt. (Same as R19)	Grid Res., V4	RC20GF203J
R22	RESISTOR, fixed: composition; 100,000 ohms, $\pm 10\%$; 1/2 watt. (Same as R3)	Plate Load Res., V4	RC20GF104K
R23	RESISTOR, fixed: composition; 120 ohms, $\pm 10\%$; 1/2 watt.	Cath. Bias Res., V4	RC20GF121K
R24	RESISTOR, fixed: composition; 47,000 ohms, $\pm 10\%$; 2 watts.	Screen Decoupl. Res., V4	RC42GF473K
R25	RESISTOR, fixed: composition; 10,000 ohms, $\pm 10\%$; 1 watt.	Plate Decoupl. Res., V4	RC30GF103K
R26	RESISTOR, fixed: composition; 12,000 ohms, $\pm 10\%$; 1/2 watt.	Grid Res., V5	RC20GF123K
R27	Not Used.		
R28	Not Used.		
R29	Not Used.		
R30	RESISTOR, variable: composition; 1 megohm, $\pm 20\%$, 2 watts, log taper.	Grid Res., V6B	RV4ATRD105D
R31	RESISTOR, fixed: composition; 390 ohms, $\pm 10\%$; 1/2 watt.	Cath. Bias Res., V6B	RC20GF391K
R32	RESISTOR, fixed: composition; 470,000 ohms, $\pm 10\%$, 1/2 watt. (Same as R2)	Audio Gain Control, V7	RC20GF474K
R33	RESISTOR, fixed: composition; 100,000 ohms, $\pm 10\%$, 1/2 watt. (Same as R3)	Plate Load Res., V7	RC20GF104K
R34	RESISTOR, fixed: composition; 560 ohms, $\pm 10\%$, 2 watts.	Cath. Bias Res., V7	RC42GF561K
R35	RESISTOR, fixed: composition; 3900 ohms, $\pm 10\%$, 1/2 watt.	Imp. Match Res., J3	RC20GF392K
R36	RESISTOR, fixed: composition; 33,000 ohms, $\pm 10\%$, 1 watt.	Decoupling Res., T1	RC30GF333K
R37	RESISTOR, fixed: composition; 22,000 ohms, $\pm 10\%$, 1/2 watt. (Same as R12)	Grid Res., V8	RC20GF223K

SYM.	DESCRIPTION	FUNCTION	TMC DWG OR PT NO.
R38	RESISTOR, fixed: composition; 120 ohms, $\pm 10\%$, 1/2 watt. (Same as R23)	Cath. Bias Res., V8	RC20GF121K
R39	RESISTOR, fixed: composition; 39,000 ohms, $\pm 10\%$, 1/2 watt.	Plate Load Res., V8	RC20GF393K
R40	RESISTOR, fixed: composition; 39,000 ohms, $\pm 10\%$, 1/2 watt. (Same as R39)	Screen Grid Res., V8	RC20GF393K
R41	RESISTOR, fixed: composition; 100,000 ohms, $\pm 10\%$, 1/2 watt. (Same as R3)	p/o 17 Kc Osc. Tank, Z4	RC20GF104K
R42	RESISTOR, fixed: composition; 22000 ohms, $\pm 10\%$, 1/2 watt. (Same as R12)	Plate Load Res., V6A	RC20GF223K
R43	RESISTOR, fixed: composition; 470,000 ohms, $\pm 10\%$, 1/2 watt. (Same as R2)	Grid Filter Res., V9	RC20GF474K
R44	RESISTOR, fixed: composition; 470,000 ohms, $\pm 10\%$, 1/2 watt. (Same as R2)	Grid Filter Res., V9	RC20GF474K
R45	RESISTOR, fixed: composition; 470,000 ohms, $\pm 10\%$, 1/2 watt. (Same as R2)	Grid Filter Res., V9	RC20GF474K
R46	RESISTOR, fixed: composition; 120,000 ohms, $\pm 10\%$, 1/2 watt.	Grid Res., V9	RC20GF124K
R47	RESISTOR, fixed: composition; 82,000 ohms, $\pm 10\%$, 1/2 watt.	p/o Phase Circuit, V9	RC20GF823K
R48	RESISTOR, variable: composition; 2500 ohms, $\pm 10\%$, 2 watts, linear taper.	React. Bal. Control, V9	RV4ATSA252A
R49	RESISTOR, fixed: composition; 180 ohms, $\pm 10\%$, 1/2 watt.	Cath. Degen. Res., V9	RC20GF181K
R50	RESISTOR, fixed: composition; 1000 ohms, $\pm 10\%$, 1/2 watt.	Cath. Bias Res., V9	RC20GF102K
R51	RESISTOR, fixed: composition; 33,000 ohms, $\pm 10\%$, 1/2 watt.	Grid Res., V9	RC20GF333K
R52	RESISTOR, fixed: composition; 56,000 ohms, $\pm 10\%$, 1/2 watt.	Plate Load Res., V9	RC20GF563K
R53	RESISTOR, fixed: composition; 390 ohms, $\pm 10\%$, 1/2 watt. (Same as R31)	Cath. Bias V10A	RC20GF391K
R54	RESISTOR, variable: composition; 1 megohm, $\pm 20\%$, 2 watts; linear taper.	Relay Thresh Control	RV4ATXA105B
R55	RESISTOR, fixed: wire wound; 4500 ohms, $\pm 5\%$, 10 watts.	B+ Dropping Res.	RW-109-47
R56	RESISTOR, fixed: composition; 56,000 ohms, $\pm 10\%$, 2 watts.	B+ Dropping Res., K1	RC42GF563K

SYM.	DESCRIPTION	FUNCTION	TMC DWG OR PT. NO.
R57	RESISTOR, fixed: composition; 1 megohm, $\pm 10\%$, 1/2 watt.	AVC T.C. Res., S1-S2	RC20GF105K
R58	RESISTOR, fixed: composition; 47,000 ohms, $\pm 10\%$, 1/2 watt.	Plate Load Res., V10B	RC20GF473K
R59	RESISTOR, fixed: composition; 470,000 ohms, $\pm 10\%$, 1/2 watt. (Same as R2)	Grid Res., V10B	RC20GF474K
R60	RESISTOR, variable: composition; 100,000 ohms, $\pm 10\%$, 2 watts, linear taper.	Tone Thresh Control	RV4ATSA104B
R61	RESISTOR, fixed: composition; 470,000 ohms, $\pm 10\%$, 1/2 watt. (Same as R2)	Grid Voltage Div. Res., V10B	RC20GF474K
R62	RESISTOR, fixed: composition; 22,000 ohms, $\pm 10\%$, 2 watts	Screen Grid Res., V3	RC42GF223K
R63	RESISTOR, fixed: composition; 47,000 ohms, $\pm 10\%$, 1/2 watt. (Same as R58)	Audio Feed-back, V5B	RC20GF473K
R64	RESISTOR, fixed: composition; 680 ohms, $\pm 10\%$, 1/2 watt.	Audio Trans., Load	RC20GF681K
R65	RESISTOR, fixed: composition; 2700 ohms, $\pm 10\%$, 1/2 watt.	30 db pad Res., T1	RC20GF272K
R66	RESISTOR, fixed: composition; 680 ohms, $\pm 10\%$, 1/2 watt. (Same as R64)	30 db pad Res., T1	RC20GF681K
R67	RESISTOR, fixed: composition; 1 megohm, $\pm 10\%$, 1/2 watt. (Same as R57)	Grid Resistor	RC20GF105K
R68	Not Used.		
R69	RESISTOR, fixed: composition; 20,000 ohms, $\pm 5\%$, 1/2 watt. (Same as R19)	Filter Load	RC20GF203J
S1	SWITCH, toggle: SPST; 3 amp at 250 v, bat type toggle.	AVC FAST/SLOW Switch	ST-12A
S2	SWITCH, toggle: SPST; 3 amp at 250 v, bat type toggle. (Same as S1)	AVC ON/OFF Switch	ST-12A
S3	Not Used.		
S4	SWITCH, rotary: 1 section; 2 position; 2 moving contacts; 6 fixed contacts.	XTAL/MANUAL Switch	SW-226
S5	SWITCH, rotary: 1 section; 2 position; 1 moving contact; 2 fixed contacts.	BFO ON/OFF Switch	SW-194
S6	SWITCH, push: SPST; 1 amp at 250 v, normally open.	SIDEBAND Switch	SW-168SPST-2-NOBB

SYM.	DESCRIPTION	FUNCTION	TMC DWG OR PT NO.
S7	SWITCH, toggle: DPST; 2 amp at 250 v, bat type toggle.	POWER/OFF Switch	ST-22K
S8	SWITCH, toggle: DPST; 2 amp at 250 v, bat type toggle. (Same as S7)	OUTPUT LEVEL	ST-22K
T1	TRANSFORMER, audio frequency: plate coupling type; primary; 5000 ohms, 35 ma; secondary: 600 ohms, tapped at 8 ohms; 5 w. maxium operating level.	Audio Output Transformer	TF-100
T2	TRANSFORMER, radio frequency: 225 microhenries, Q=75; tapped at 115 microhenries, Q=50; tuning core included.	p/o Bandpass Filter, Z3	p/o A-1387
T3	TRANSFORMER, audio frequency: input type; 43.5 millihenries; Q=20; 10.5 ohms; 2 taps.	p/o Second Osc. Tank, Z4	A-1382
T4	TRANSFORMER, audio frequency: input type; 43.5 millihenries; Q=20; 10.5 ohms; tapped.	p/o Side Tone Gen. Tank Z5	A-1383
T5	TRANSFORMER, power: step-down and step-up; primary: 110 or 220 v, 50 to 60 cps; secondary: 5 v at 2 amps, center tapped, 6.3 v at 5 amps, center tapped, 340 v at 100 ma dc center tapped.	Power Transformer	TF-101
V1	TUBE, electron: medium-mu duo triode; 9 pin miniature.	AVC Ampl. Rect.	12AU7
V2	TUBE, electron: remote cutoff RF pentode; 7 pin miniature.	IF Amplifier	6BA6
V3	TUBE, electron: heptode converter; 7 pin miniature.	First Mixer	6BE6
V4	TUBE, electron: heptode converter; 7 pin miniature. (Same as V3)	Second Mixer	6BE6
V5	TUBE, electron: duo triode; 9 pin miniature.	Second Osc-Audio Amplifier	12AT7
V6	TUBE, electron: beam power amplifier; 7 pin miniature.	Audio Output	6AQ5
V7	TUBE, electron: sharp cutoff RF pentode; 7 pin miniature.	First Osc.	6AG5
V8	TUBE, electron: duo-triode; 7 pin miniature.	React. Mod.	6J6
V9	TUBE, electron: medium-mu duo-triode; 9 pin miniature. Same as V1	Relay Driver-Side Tone Gen.	12AU7

SYM.	DESCRIPTION	FUNCTION	TMC DWG OR PT NO.
V10	TUBE, electron: full-wave rectifier ; octal base.	Power Rect.	5Y3GT
V11	TUBE, electron: voltage regulator; 7 pin miniature.	Voltage Reg.	OA2
W1	CABLE ASSEMBLY, power, electrical: 3 conductor, 6 ft. long, w/integral male plug with pigtail ground lead one end, and MS-3106A-16S-5S with MS-3057-8 clamp on other end.	AC Line Cord	CA-385
XF1	FUSEHOLDER, extractor post type: 250 v, 15 amp.	Socket for F1	FH-100-2
XI1	LIGHT, indicator: w/green faceted lens; for miniature bayonet base T-3-1/4 bulb.	Socket for I1	TS-133
XI2	LIGHT, indicator: w/green faceted lens; for miniature bayonet base T-3-1/4 bulb.	Socket for I2	TS-133
XI3	LIGHT, indicator: w/red frosted lens; for miniature bayonet base T-3-1/4 bulb.	Socket for I3	TS-106-1
XV1	SOCKET, electron tube: 9 pin miniature.	Socket for V1	TS103P01
XV2	SOCKET, electron tube: 7 pin miniature.	Socket for V2	TS102P01
XV3	SOCKET, electron tube: 7 pin miniature. (Same as XV2)	Socket for V3	TS102P01
XV4	SOCKET, electron tube: 7 pin miniature. (Same as XV2)	Socket for V4	TS102P01
XV5	SOCKET, electron tube: 9 pin miniature. (Same as XV1)	Socket for V5	TS103P01
XV6	SOCKET, electron tube: 7 pin miniature. (Same as XV2)	Socket for V6	TS102P01
XV7	SOCKET, electron tube: 7 pin miniature. (Same as XV2)	Socket for V7	TS102P01
XV8	SOCKET, electron tube: 7 pin miniature. (Same as XV2)	Socket for V8	TS102P01
XV9	SOCKET, electron tube: 9 pin miniature. (Same as XV1)	Socket for V9	TS103P01
XV10	SOCKET, electron tube: octal.	Socket for V10	TS101P01
XV11	SOCKET, electron tube: 7 pin miniature. (Same as XV2)	Socket for V11	TS102P01

SYM.	DESCRIPTION	FUNCTION	TMC DWG OR PT NO.
XY1	SOCKET, crystal: 2 contacts; 0.486 in. spacing for .050 in. pin diam; steatite body.	Socket for Y1	TS-104-1
XY2	SOCKET, crystal: 2 contacts; 0.486 in. spacing for .050 in. pin diam; steatite body. (Same as XY1)	Socket for Y2	TS-104-1
Y1	CRYSTAL UNIT, quartz: 438 kc, $\pm 0.01\%$; includes holder HC-6/U.	438 kc Crystal	CR46/U-.4380-P
Y2	CRYSTAL UNIT, quartz: 472 kc, $\pm 0.01\%$; includes holder HC-6/U.	472 kc Crystal	CR46/U-.4720-P
Z1	FILTER, bandpass: 19.1 kc; 3.4 kc bandwidth; 10,000 ohms impedance.	Bandpass Filter	FX-153
Z2	FILTER, low-pass: 3500 cps cut-off frequency.	Low-pass Filter	FX-152
Z3	TRANSFORMER, radio frequency: 730 kc; (consists of C32 & T2).	First Osc. Tank	A-1387
Z4	OSCILLATOR NETWORK, audio frequency: 17 kc; (consists of C38, 39, 40, 50, R41 & T3).	Second Osc. Tank	A-1381
Z5	OSCILLATOR NETWORK, audio frequency: 43.5 millihenries (consists of C53,55, T4).	Side Tone Gen. Tank	A-1384

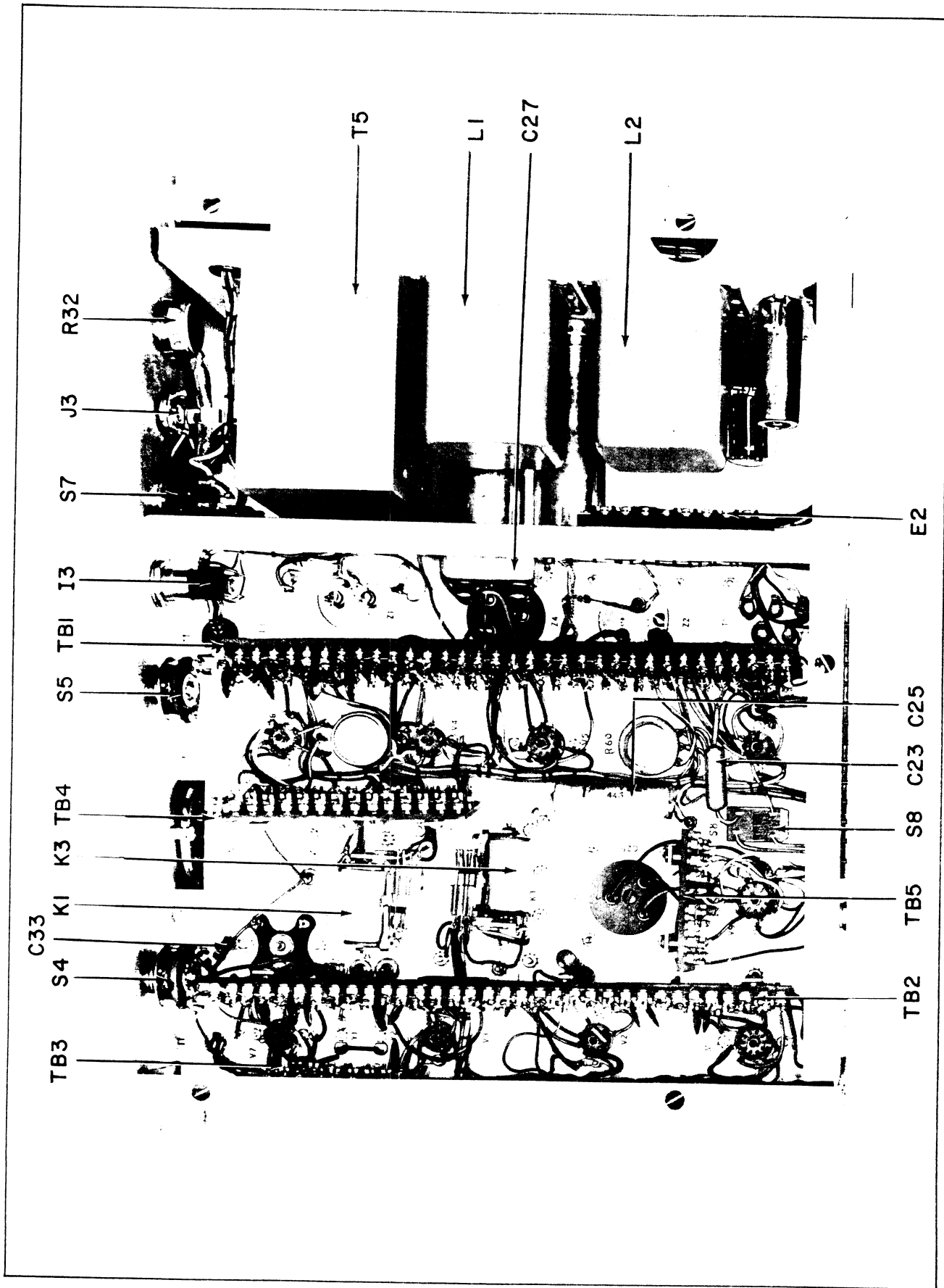

Figure 5-2. Bottom View Model MSR

PH-620R

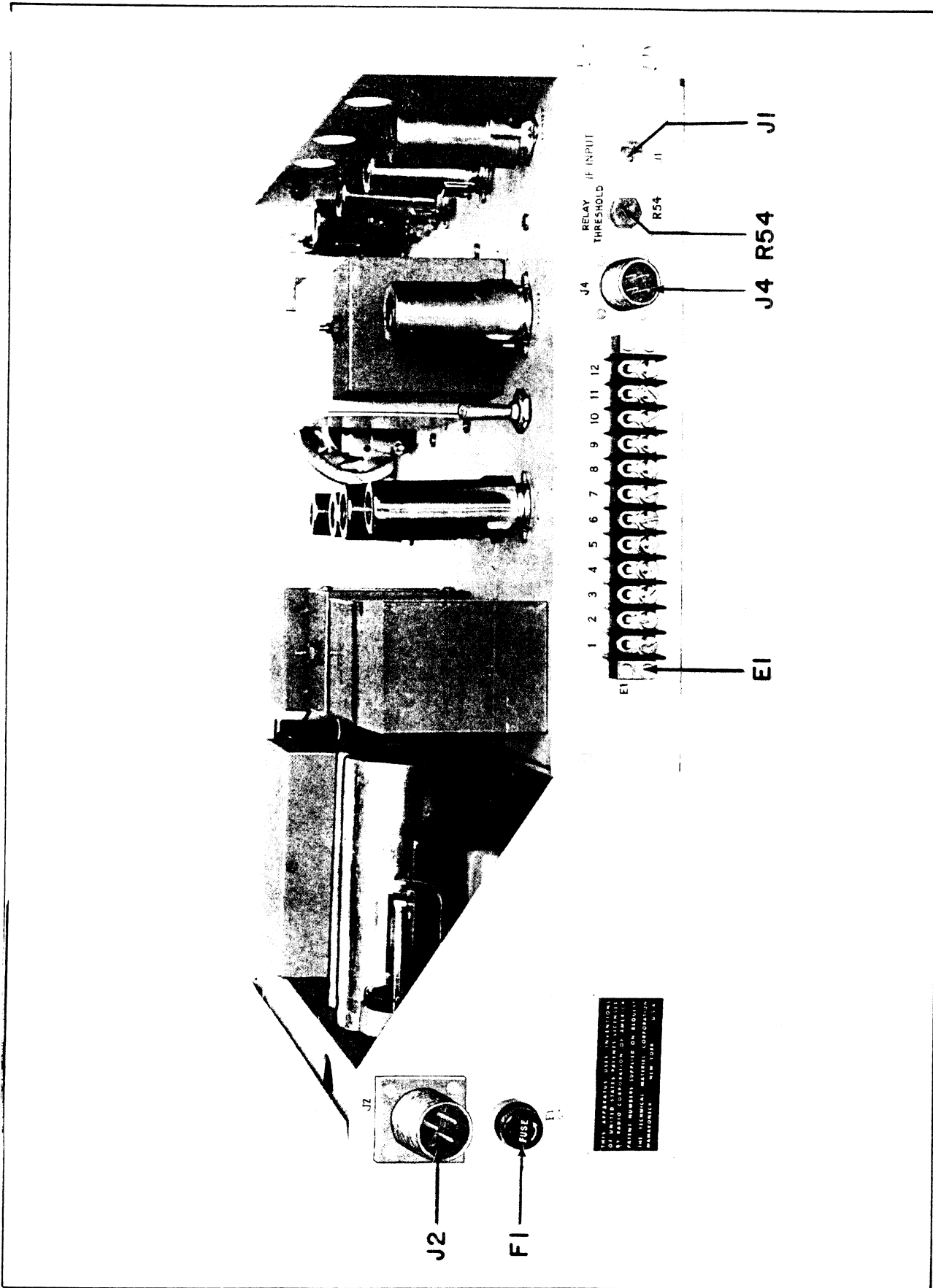
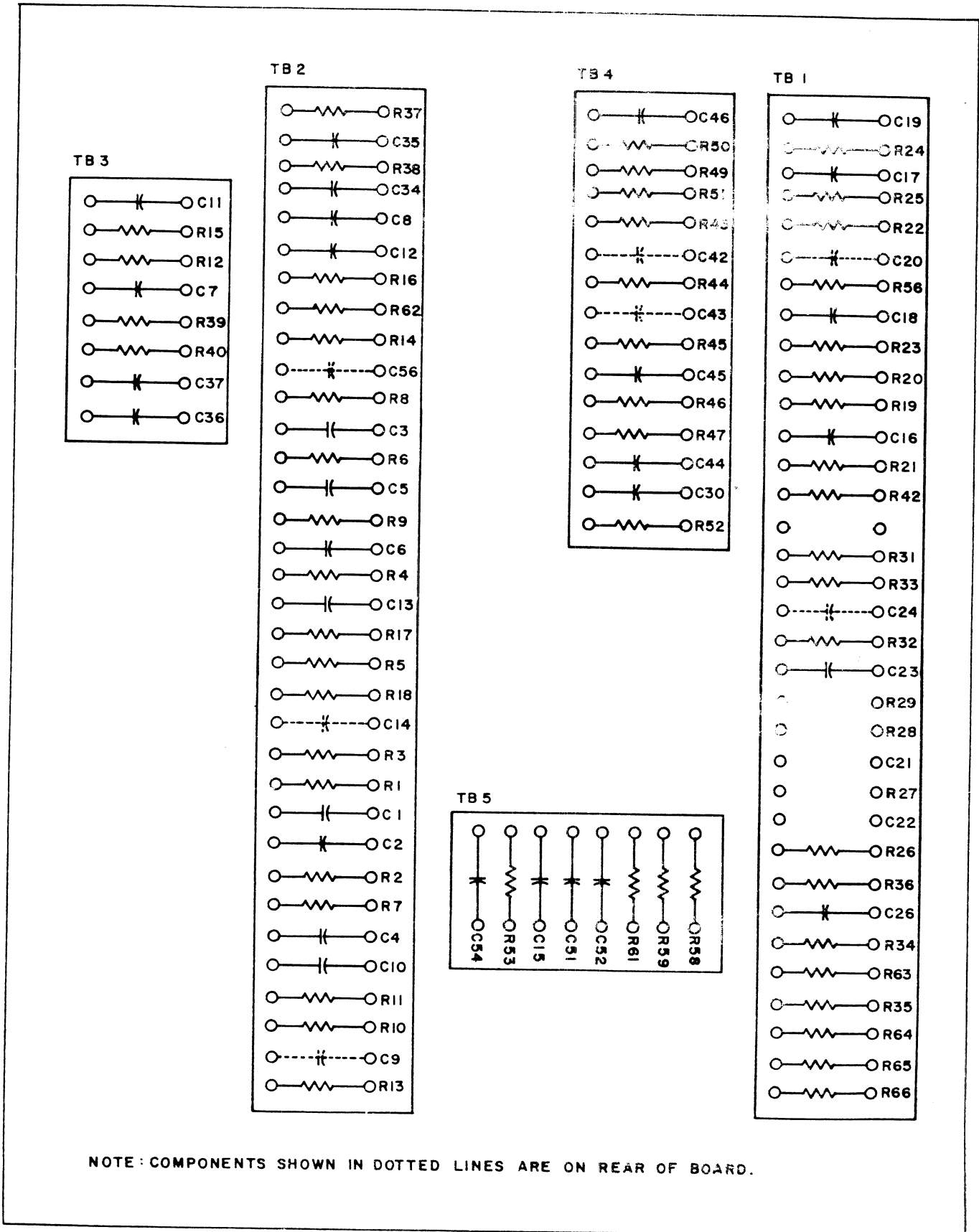

Figure 5-3. Rear View Model MSR



NOTE: COMPONENTS SHOWN IN DOTTED LINES ARE ON REAR OF BOARD.

Figure 5-4. Terminal Board Layout Model MSR

